

Varenummer: 40600701672440

Beskrivelse: Tandhjulsgeær C702F-16,7-P100B5

## Mål

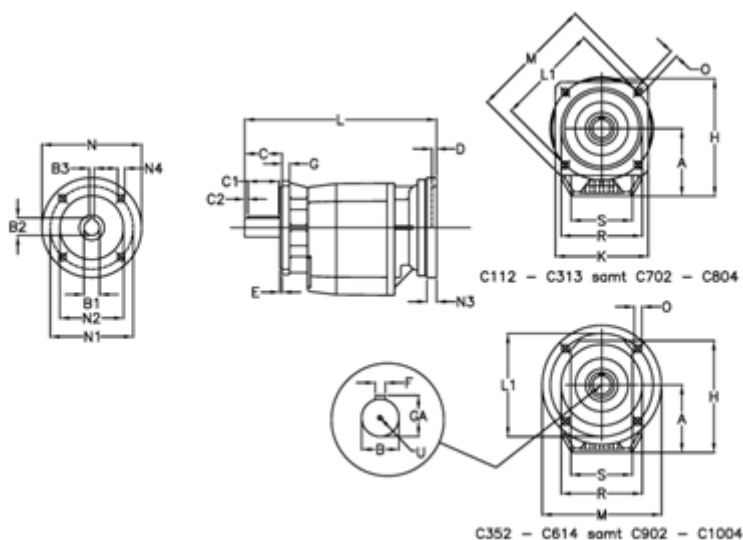

A = 208.0

B = 60

B1 = 28

B2 = 31.3

B3 = 8

C = 120

C1 = 90

C2 = 15

D = 4.5

E = 5

F = 18

G = 17

GA = 64.0

H = 358.0

K = 300

L = 483.0

L1 = 300

M = 350

N = 250

N1 = 215

N2 = 180

N3 = 0

N4 = M12x16

O = 18.0

R = 262

S = 250

U = M20x42